

### General Description

The MDFS11N60 uses advanced Magnachip's MOSFET Technology, which provides low on-state resistance, high switching performance and excellent quality.

MDFS11N60 is suitable device for SMPS, high Speed switching and general purpose applications.

### Features

- $V_{DS} = 600V$
- $I_D = 11A$  @  $V_{GS} = 10V$
- $R_{DS(ON)} \leq 0.55\Omega$  @  $V_{GS} = 10V$

### Applications

- Power Supply
- PFC
- High Current, High Speed Switching

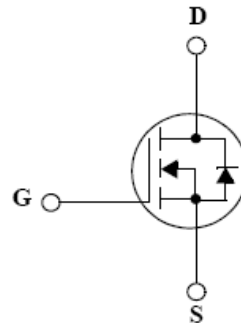

### Absolute Maximum Ratings (Ta = 25°C)

| Characteristics                              | Symbol         | Rating             | Unit |      |
|--|----------------|--------------------|------|------|
| Drain-Source Voltage                         | $V_{DSS}$      | 600                | V    |      |
| Gate-Source Voltage                          | $V_{GSS}$      | ±30                | V    |      |
| Continuous Drain Current (※)                 | $I_D$          | $T_C=25^\circ C$   | 11   | A    |
|  |                | $T_C=100^\circ C$  | 6.9  | A    |
| Pulsed Drain Current <sup>(1)</sup>          | $I_{DM}$       | 44                 | A    |      |
| Power Dissipation                            | $P_D$          | $T_C=25^\circ C$   | 49   | W    |
|  |                | Derate above 25 °C | 0.39 | W/°C |
| Peak Diode Recovery $dv/dt$ <sup>(3)</sup>   | $dv/dt$        | 4.5                | V/ns |      |
| Single Pulse Avalanche Energy <sup>(4)</sup> | $E_{AS}$       | 720                | mJ   |      |
| Junction and Storage Temperature Range       | $T_J, T_{stg}$ | -55~150            | °C   |      |

※  $I_D$  limited by maximum junction temperature

### Thermal Characteristics

| Characteristics  | Symbol          | Rating | Unit |
|--|-----------------|--------|------|
| Thermal Resistance, Junction-to-Ambient <sup>(1)</sup> | $R_{\theta JA}$ | 62.5   | °C/W |
| Thermal Resistance, Junction-to-Case <sup>(1)</sup>    | $R_{\theta JC}$ | 2.55   |      |

## Ordering Information

| Part Number | Marking   | Temp. Range | Package                  | Packing | RoHS Status  |
|-------------|-----------|-------------|--------------------------|---------|--------------|
| MDFS11N60TH | MDFS11N60 | -55~150°C   | TO-220F(Thin lead frame) | Tube    | Halogen Free |

## Electrical Characteristics (Ta = 25°C)

| Characteristics  | Symbol       | Test Condition   | Min | Typ  | Max  | Unit     |
|--|--------------|--|-----|------|------|----------|
| <b>Static Characteristics</b>                            |              |  |     |      |      |          |
| Drain-Source Breakdown Voltage                           | $BV_{DSS}$   | $I_D = 250\mu A, V_{GS} = 0V$                            | 600 | -    | -    | V        |
| Gate Threshold Voltage                                   | $V_{GS(th)}$ | $V_{DS} = V_{GS}, I_D = 250\mu A$                        | 3.0 | -    | 5.0  | V        |
| Drain Cut-Off Current                                    | $I_{DSS}$    | $V_{DS} = 600V, V_{GS} = 0V$                             | -   | -    | 1    | $\mu A$  |
| Gate Leakage Current                                     | $I_{GSS}$    | $V_{GS} = \pm 30V, V_{DS} = 0V$                          | -   | -    | 100  | nA       |
| Drain-Source ON Resistance                               | $R_{DS(ON)}$ | $V_{GS} = 10V, I_D = 5.5A$                               | -   | 0.45 | 0.55 | $\Omega$ |
| Forward Transconductance                                 | $g_{fs}$     | $V_{DS} = 30V, I_D = 5.5A$                               | -   | 13   | -    | S        |
| <b>Dynamic Characteristics</b>                           |              |  |     |      |      |          |
| Total Gate Charge  | $Q_g$        | $V_{DS} = 480V, I_D = 11A, V_{GS} = 10V$                 | -   | 38.4 | -    | nC       |
| Gate-Source Charge                                       | $Q_{gs}$     |  | -   | 11.2 | -    |          |
| Gate-Drain Charge  | $Q_{gd}$     |  | -   | 14   | -    |          |
| Input Capacitance  | $C_{iss}$    | $V_{DS} = 25V, V_{GS} = 0V, f = 1.0MHz$                  | -   | 1700 | -    | pF       |
| Reverse Transfer Capacitance                             | $C_{riss}$   |  | -   | 6.2  | -    |          |
| Output Capacitance                                       | $C_{oss}$    |  | -   | 184  | -    |          |
| Turn-On Delay Time                                       | $t_{d(on)}$  | $V_{GS} = 10V, V_{DS} = 300V, I_D = 11A, R_G = 25\Omega$ | -   | 38   | -    | ns       |
| Rise Time  | $t_r$        |  | -   | 50   | -    |          |
| Turn-Off Delay Time                                      | $t_{d(off)}$ |  | -   | 76   | -    |          |
| Fall Time  | $t_f$        |  | -   | 33   | -    |          |
| <b>Drain-Source Body Diode Characteristics</b>           |              |  |     |      |      |          |
| Maximum Continuous Drain to Source Diode Forward Current | $I_S$        |  | -   | 11   | -    | A        |
| Source-Drain Diode Forward Voltage                       | $V_{SD}$     | $I_S = 11A, V_{GS} = 0V$                                 | -   | -    | 1.4  | V        |
| Body Diode Reverse Recovery Time                         | $t_{rr}$     | $I_F = 11A, di/dt = 100A/\mu s$                          | -   | 430  | -    | ns       |
| Body Diode Reverse Recovery Charge                       | $Q_{rr}$     |  | -   | 4.0  | -    | $\mu C$  |

Note :

1. Pulse width is based on  $R_{\theta JC}$  &  $R_{\theta JA}$  and the maximum allowed junction temperature of 150°C.
2. Pulse test: pulse width  $\leq 300\mu s$ , duty cycle  $\leq 2\%$ , pulse width limited by junction temperature  $T_{J(MAX)}=150^\circ C$ .
3.  $I_{SD} \leq 11A$ ,  $di/dt \leq 200A/\mu s$ ,  $V_{DD}=50V$ ,  $R_G = 25\Omega$ , Starting  $T_J=25^\circ C$
4.  $L=10.9mH$ ,  $I_{AS}=11A$ ,  $V_{DD}=50V$ ,  $R_G = 25\Omega$ , Starting  $T_J=25^\circ C$

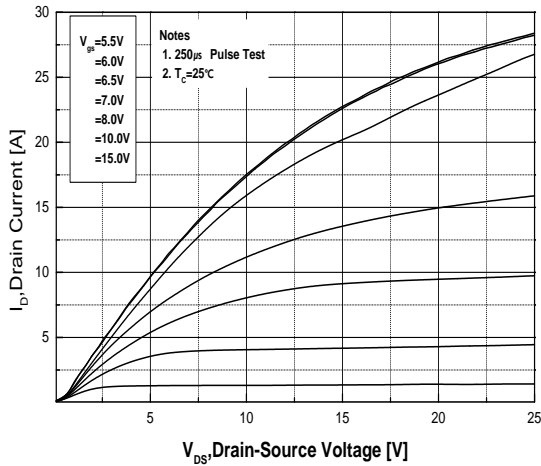

**Fig.1 On-Region Characteristics**

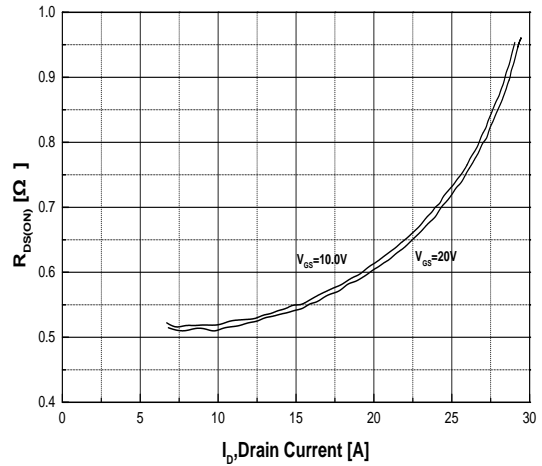

**Fig.2 On-Resistance Variation with Drain Current and Gate Voltage**

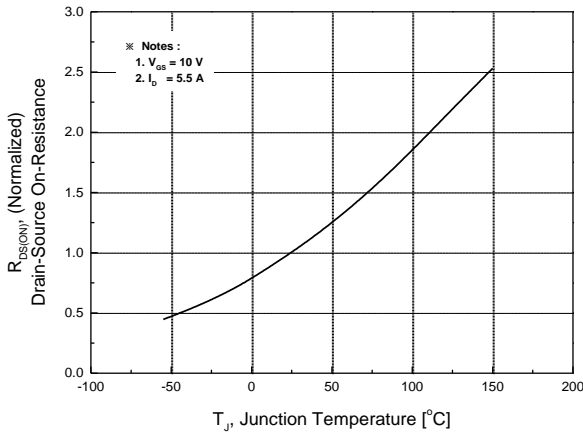

**Fig.3 On-Resistance Variation with Temperature**

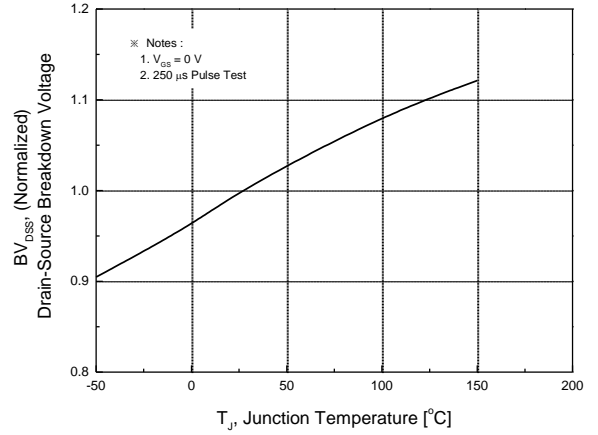

**Fig.4 Breakdown Voltage Variation vs. Temperature**

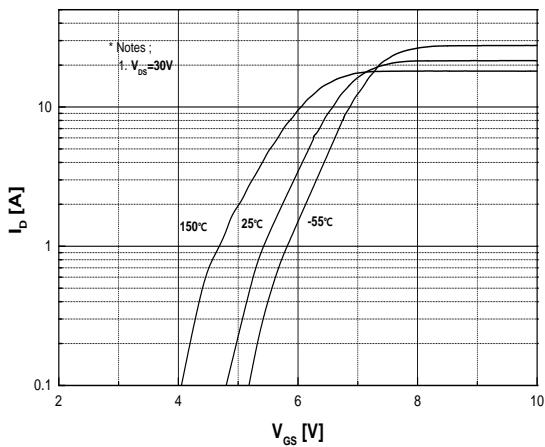

**Fig.5 Transfer Characteristics**

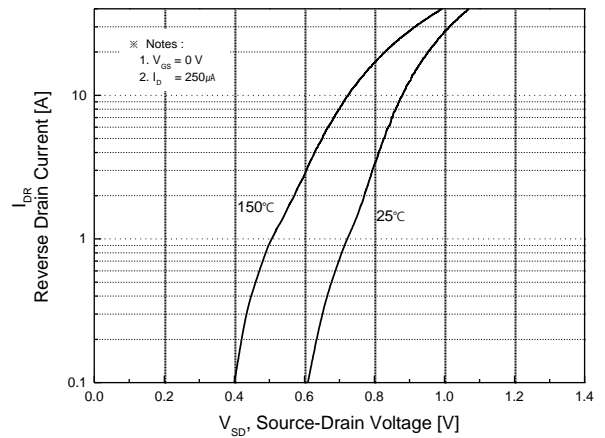

**Fig.6 Body Diode Forward Voltage Variation with Source Current and Temperature**

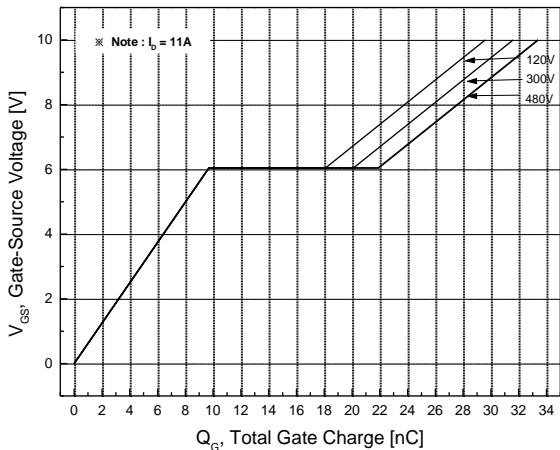

**Fig.7 Gate Charge Characteristics**

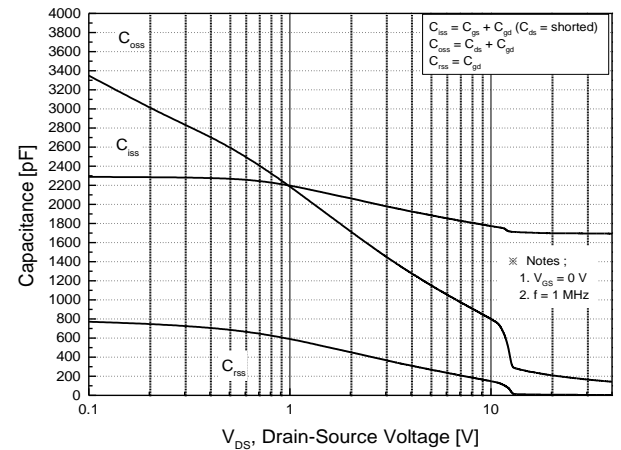

**Fig.8 Capacitance Characteristics**

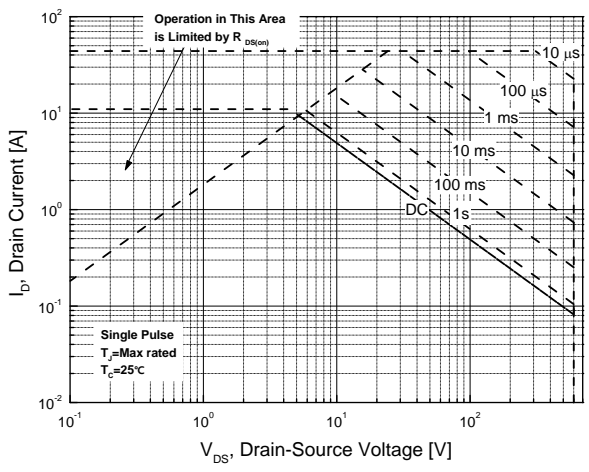

**Fig.9 Maximum Safe Operating Area**

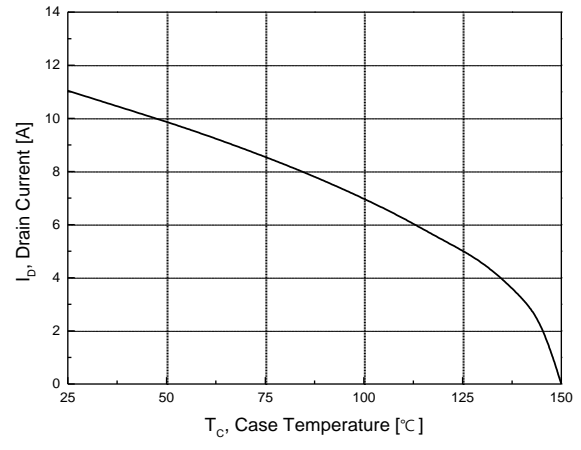

**Fig.10 Maximum Drain Current vs. Case Temperature**

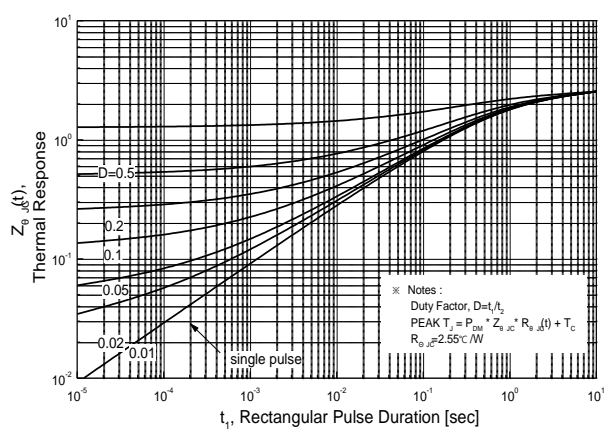

**Fig.11 Transient Thermal Response Curve**

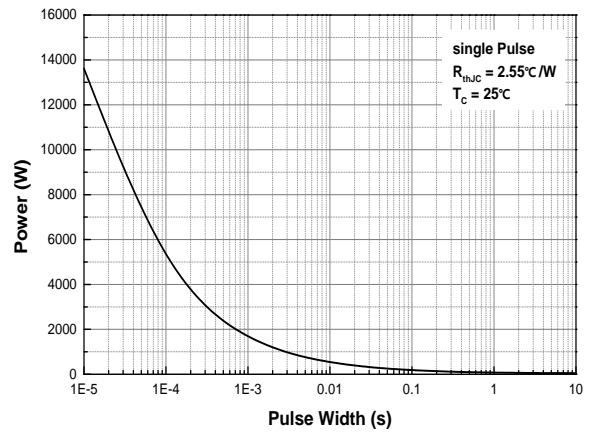
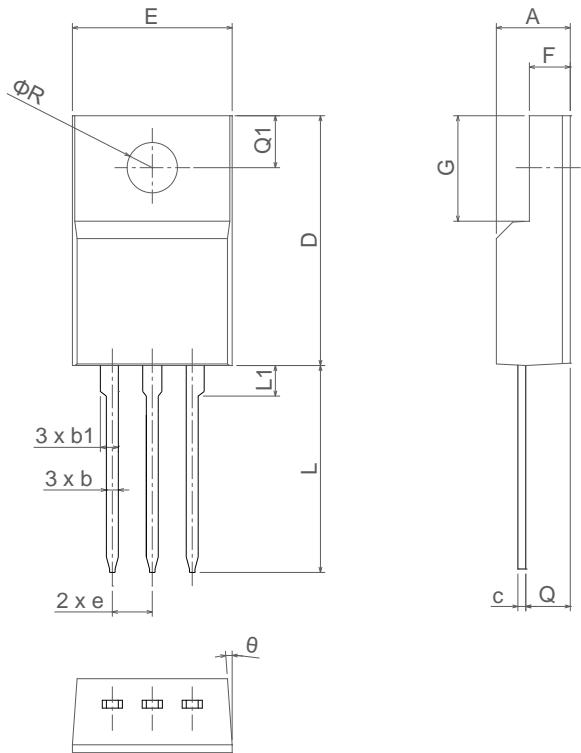

**Fig.12 Single Pulse Maximum Power Dissipation**

**Physical Dimensions**

**TO-220F(Thin lead frame)**

Dimensions are in millimeters unless otherwise specified



| Symbol   | Dimension [mm] |     |       |
|----------|----------------|-----|-------|
|          | Min            | Nom | Max   |
| A        | 4.55           | -   | 4.85  |
| b        | 0.59           | -   | 0.79  |
| b1       | 1.14           | -   | 1.22  |
| c        | 0.45           | -   | 0.60  |
| D        | 15.72          | -   | 16.02 |
| E        | 10.01          | -   | 10.31 |
| e        | 2.54 BSC       |     |       |
| F        | 2.42           | -   | 2.74  |
| G        | 6.55           | -   | 6.85  |
| L        | 12.80          | -   | 13.20 |
| L1       | 1.85           | -   | 2.15  |
| Q        | 2.66           | -   | 2.86  |
| Q1       | 3.20           | -   | 3.40  |
| $\Phi R$ | 3.08           | -   | 3.28  |
| $\theta$ | 5°             | -   | 9°    |

**DISCLAIMER:**

The Products are not designed for use in hostile environments, including, without limitation, aircraft, nuclear power generation, medical appliances, and devices or systems in which malfunction of any Product can reasonably be expected to result in a personal injury. Seller's customers using or selling Seller's products for use in such applications do so at their own risk and agree to fully defend and indemnify Seller.

Magnachip reserves the right to change the specifications and circuitry without notice at any time. Magnachip does not consider responsibility for use of any circuitry other than circuitry entirely included in a Magnachip product.  Magnachip is a registered trademark of Magnachip Semiconductor Ltd.