

# MAP3612

## 2-CH Average Current Control Buck Controller for LED Backlight

### General Description

MAP3612 is a 2 channel average-mode current control buck controller for LED backlight application. It does not require an additional dimming MOSFET and utilizes constant off-time control and average current control feedback without external loop compensation or high-side current sensing.

MAP3612 features  $\pm 1\%$  CS voltage accuracy and has dedicated analog dimming input up to 3V. It can be powered from 8.5V ~ 18V supply.

MAP3612 provides MOSFET DS short detection (FLT output), SCP, ODP and UVLO.

MAP3612 is available 16 leads SOIC with Halogen-free (fully RoHS compliant).



### Features

- 8.5V to 18V Input Voltage Range
- Average-Mode Current Control
- Programmable Constant Off-time
  - Independent Setting per Channel
- Up to 3V Analog Dimming Input
- 1% CS Voltage Accuracy
- Independent Direct PWM Dimming Input
- Fault Output
  - MOSFET Drain-Source Short
- Short Circuit Protection
- Over-Duty Protection
- UVLO
- 16 Leads SOIC Package with Halogen-free

### Applications

- High Brightness white LED backlighting for LCD TVs
- General LED lighting applications

### Ordering Information

Part Number	Top Marking	Ambient Temperature Range	Package	RoHS Status
MAP3612SIRH	MAP3612	-40°C to +85°C	16Leads SOIC	Halogen Free

### Typical Application

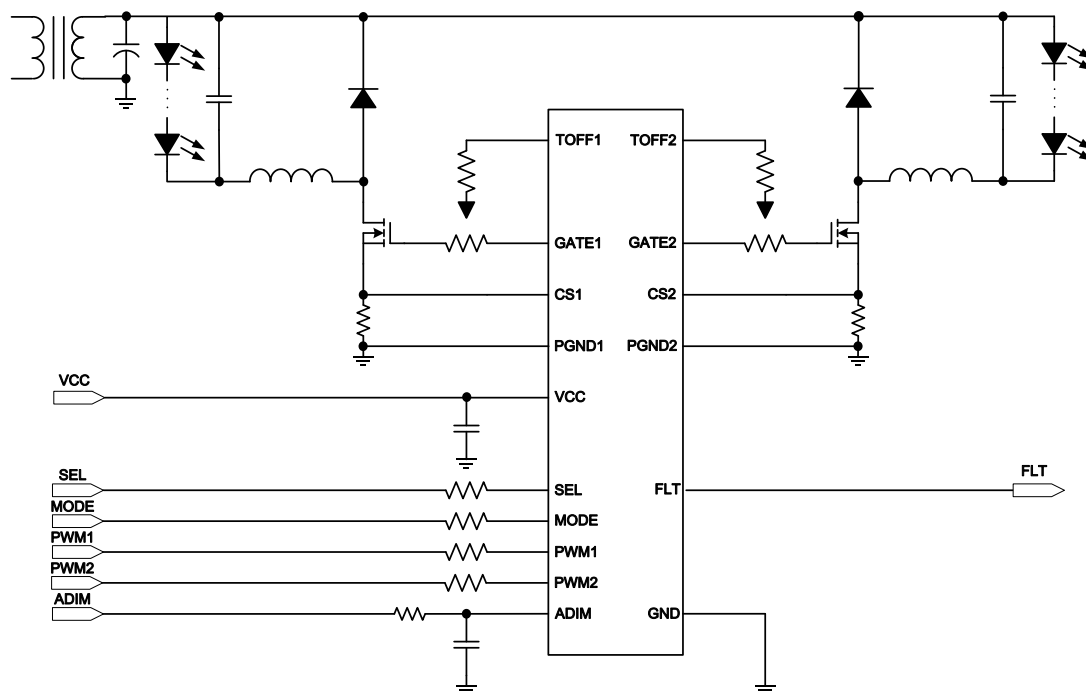

### Pin Configuration

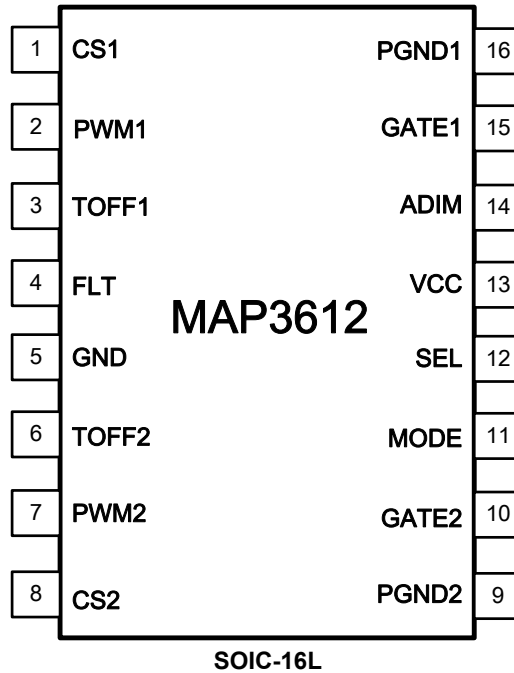

### Pin Description

16leads SOIC	Name	Description
1	CS1	External current sense for CH1(Note 1).
2	PWM1	PWM signal input for CH1.
3	TOFF1	Setting for GATE off-time for CH1(Note 2)
4	FLT	Fault Output
5	GND	Ground
6	TOFF2	Setting for GATE off-time for CH2(Note 2)
7	PWM2	PWM signal input for CH2.
8	CS2	External current sense for CH2(Note 3).
9	PGND2	Power GND for CH2
10	GATE2	GATE driver output to drive external NMOSFET for CH2
11	MODE	Enable logic input for Over-Duty protection. Default logic 'Low' (Note 4)
12	SEL	Logic input for selecting OD1 or OD2 protection. Default logic 'Low' (Note 5)
13	VCC	Power supply input. Need external bypass capacitor
14	ADIM	Setting for LED current thru external DC voltage
15	GATE1	GATE driver output to drive external NMOSFET for CH1
16	PGND1	Power GND for CH1

**Note 1:** Connect external resistor to PGND1 to sense the external power MOSFET source current as shown in typical application

**Note 2:** Connect external resistor to GND to set GATE off-time as shown in typical application

**Note 3:** Connect external resistor to PGND2 to sense the external power MOSFET source current as shown in typical application

**Note 4:** Logic 'H' → ODP disable, Logic 'L' or floating → ODP enable

**Note 5:** Logic 'H' → OD1 protection, Logic 'L' or floating → OD2 protection

Functional Block Diagram

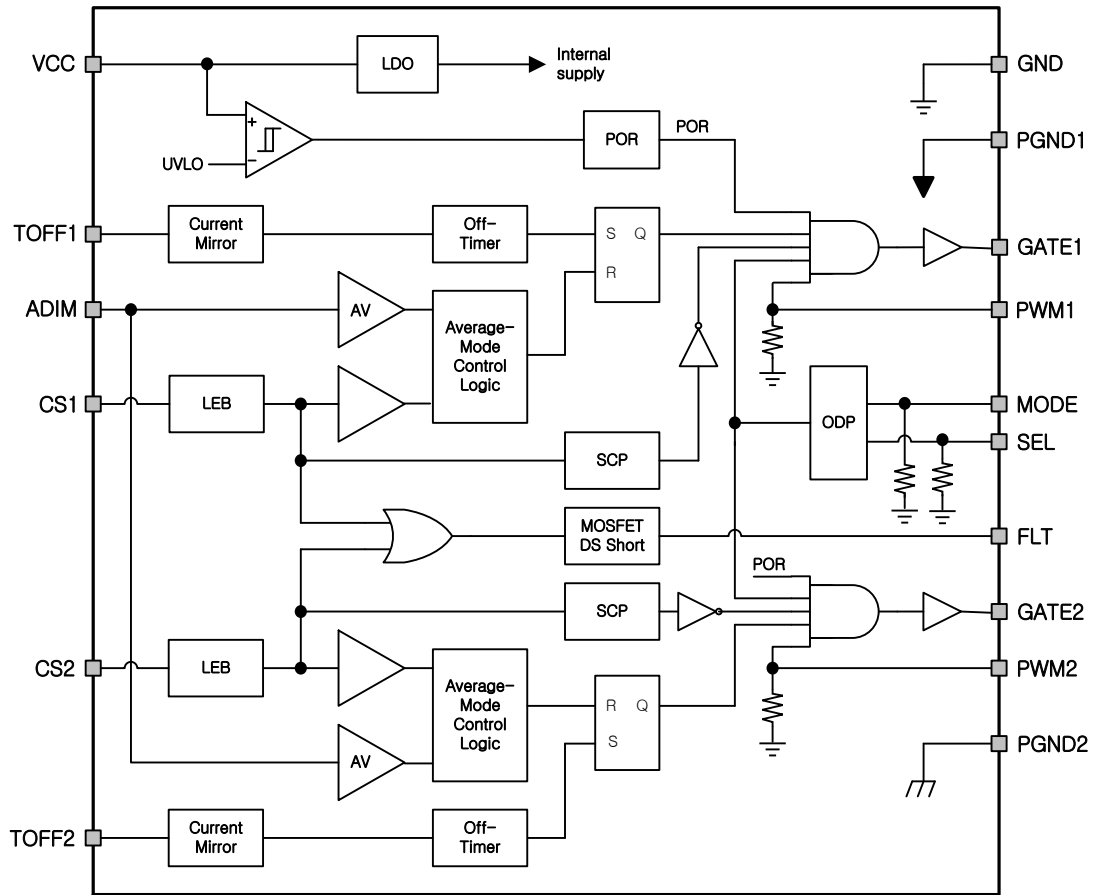

**Absolute Maximum Ratings** (Note 1)

Symbol	Parameter	Min	Max	Unit
$V_{VCC}, V_{GATE1}, V_{GATE2}, V_{PWM1}, V_{PWM2}, V_{MODE}, V_{SEL}$	VCC, GATE1, GATE2, PWM1, PWM2, MODE, SEL pins Voltage	-0.3	20	V
$V_{CS1}, V_{CS2}, V_{TOFF1}, V_{TOFF2}, V_{ADIM}, V_{FLT}$	CS1, CS2, TOFF1, TOFF2, ADIM, FLT pins Voltage	-0.3	5	V
$T_{PAD}$	Soldering Lead/ Pad Temperature 10sec		300	°C
$T_J$	Junction Temperature	-40	+150	°C
$T_S$	Storage Temperature	-65	+150	°C
ESD	HBM on All Pins (Note 2)	-2000	+2000	V
	MM on All Pins (Note 3)	-200	+200	

**Note 1:** Stresses beyond the above listed maximum ratings may damage the device permanently. Operating above the recommended conditions for extended time may stress the device and affect device reliability. Also the device may not operate normally above the recommended operating conditions. These are stress ratings only.

**Note 2:** ESD tested per JESD22A-114.

**Note 3:** ESD tested per JESD22A-115.

**Recommended Operating Conditions** (Note 1)

Parameter	Min	Max	Unit
$V_{VCC}$ Supply Input Voltage	8.5	18.0	V
$V_{ADIM}$ ADIM Input Range	0.5	3.0	V
$T_A$ Ambient Temperature (Note 2)	-40	+85	°C

**Note 1:** Normal operation of the device is not guaranteed if operating the device over outside range of recommended conditions.

**Note 2:** The ambient temperature may have to be derated if used in high power dissipation and poor thermal resistance conditions.

**Package Thermal Resistance** (Note 1)

Parameter	$\theta_{JA}$	$\theta_{JC}$	Unit
MAP3612SIRH 16 Leads SOIC	65.1	25.3	°C/W

**Note 1:** Multi-layer PCB based on JEDEC standard (JE51-7)

## Electrical Characteristics

Unless noted,  $V_{VCC} = 12V$ ,  $C_{VCC} = 1.0\mu F$ , and typical values are tested at  $T_A = 25^\circ C$ .

Parameter		Test Condition	Min	Typ	Max	Unit
<b>Supply</b>						
$V_{VCC}$	Input Voltage Range		8.5		18	V
$I_Q$	Quiescent Current	$V_{PWM} = 5V, V_{CS} = 0V$		3.4		mA
$V_{UVLO}$	Under Voltage Lockout Threshold Voltage on VCC pin	Release threshold(rising $V_{VCC}$ )	7.5	8.0	8.5	V
		Lockout hysteresis(falling $V_{VCC}$ )	0.5	1.0	1.5	
<b>OFF Timer</b>						
$t_{OFFx}$	GATE1/2 Off-time	$R_{TOFFx}=52k\Omega$	4.5	5.0	5.5	us
		$R_{TOFFx}=104k\Omega$	9	10	11	
$t_{ON\_MIN}$	Min. On-Time			300		ns
$t_{ON\_MAX}$	Max. On-Time	$V_{ADIM} = 3V$		37		us
$t_{OFF\_MIN}$	Min. Off-Time			1.2	1.5	us
$D_{MAX}$	Max. Duty Cycle	$V_{ADIM} = 3V, t_{OFF}=1.2us$		97		%
<b>GATE Driver</b>						
$I_{SOURCE}$	GATE1/2 Source Current	$V_{GATE1/2} = 0V,$	400			mA
$I_{SINK}$	GATE1/2 Sink Current	$V_{GATE1/2} = V_{VCC}=12V$	800			mA
$t_{RISE}$	GATE1/2 Output Rising Time	$C_{GATE1/2}=1nF, V_{VCC} = 12V$		50	85	ns
$t_{FALL}$	GATE1/2 Output Falling Time	$C_{GATE1/2}=1nF, V_{VCC} = 12V$		25	45	ns
<b>Current Sense &amp; Dimming</b>						
$V_{ADIM}$	ADIM Input Voltage Range		0.5		3.0	V
$A_V$	VADIM to CS1/2 Voltage Ratio			0.5075		V/V
$V_{CS1/2}$	CS1/2 Voltage	$V_{ADIM} = 0.5V$	0.2512		0.2563	V
		$V_{ADIM} = 3.0V$	1.5073		1.5377	
$t_{LEB}$	Leading Edge Blanking Time			300		ns
<b>Logic Interface</b>						
$V_{PWM1/2}$	Logic Input Level on PWM1/2 pins	$V_{PWM1/2\_L}$ : Logic Low			0.8	V
		$V_{PWM1/2\_H}$ : Logic High	2.0			
$R_{PWM1/2}$	Pull-down Resistor on PWM1/2 pins	$V_{PWM1/2} = 4V$	50	100	150	k $\Omega$
$V_{MODE}$	Logic Input Level on MODE pin	$V_{MODE\_L}$ : Logic Low			0.8	V
		$V_{MODE\_H}$ : Logic High	2.0			
$R_{MODE}$	Pull-down Resistor on MODE pin	$V_{MODE} = 4V$	50	100	150	k $\Omega$
$V_{SEL}$	Logic Input Level on SEL pin	$V_{SEL\_L}$ : Logic Low			0.8	V
		$V_{SEL\_H}$ : Logic High	2.0			
$R_{SEL}$	Pull-down Resistor on SEL pin	$V_{SEL} = 4V$	50	100	150	k $\Omega$
<b>Protection</b>						
$A_{VSCP}$	$V_{ADIM}$ to SCP Voltage Ratio	$0.5 \leq V_{ADIM} \leq 2.5V$		1.7		V/V
$V_{SCP}$	SCP Detection Threshold Voltage on CS1/2 pins	$V_{ADIM} = 0.5V$	0.8075	0.8500	0.8925	V
		$V_{ADIM} = 1.0V$	1.6150	1.7000	1.7850	
		$V_{ADIM} = 2.5V$	4.0375	4.2500	4.4625	
$t_{DELAY}$	SCP Delay Time			300		ns
$t_{RESTART}$	Restart Time			1		ms
$V_{SCPDS}$	MOSFET DS Short Detection Threshold Voltage on CS1/2 pins	$V_{ADIM} = 0.5V$ (Note 1, 2)		0.25		V
		$V_{ADIM} = 2.5V$ (Note 1, 2)		1.25		
$V_{FLT}$	FLT pin High Voltage		4.5		5	V
$R_{FLT}$	FLT pin Internal Resistance	$V_{FLT}$ : Logic High	2.5		5	k $\Omega$
$D_{OD1}$	Protection Duty for OD1		55	57	59	%
$D_{OD2}$	Protection Duty for OD2		35	37	39	%
$t_{OD}$	Auto-Restart time for OD1/2	$V_{MODE} = GND$ or Floating		100		ms

**Note 1:** These parameters, although guaranteed by design, are not tested in mass production.

**Note 2:** At start-up( $V_{VCC} \geq V_{UVLO}$  release threshold)

### Typical Operating Characteristics

Unless otherwise noted,  $V_{CC} = 12V$  and  $T_A = 25^\circ C$ .

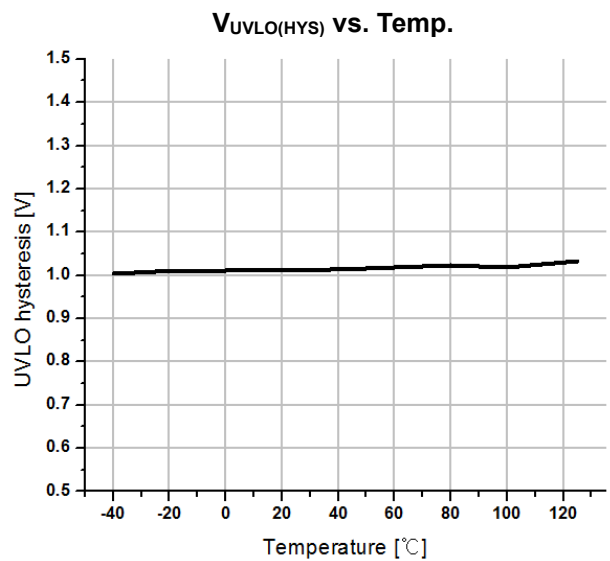
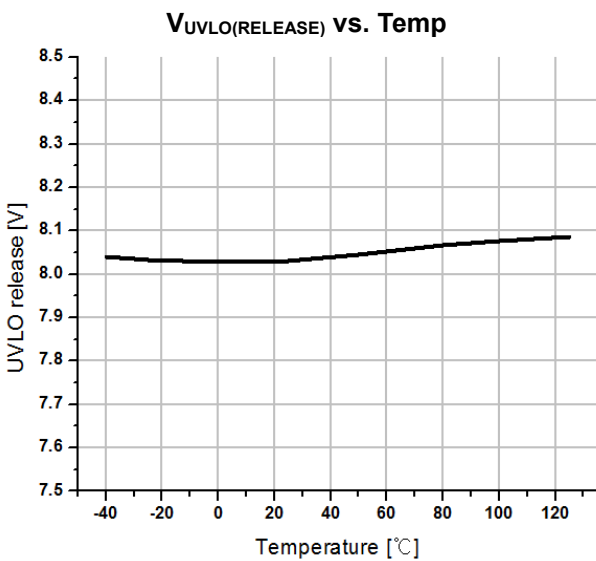
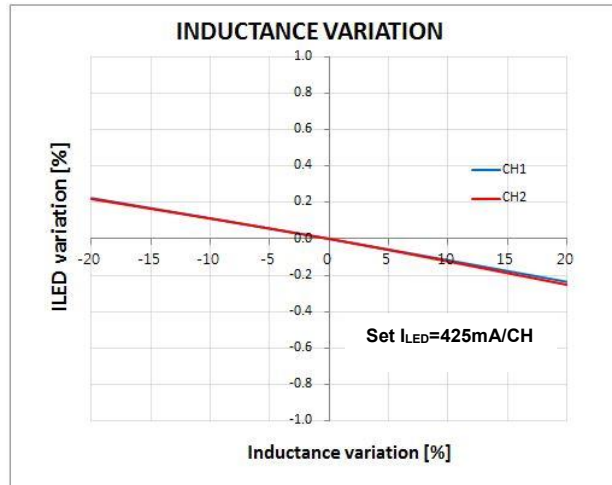
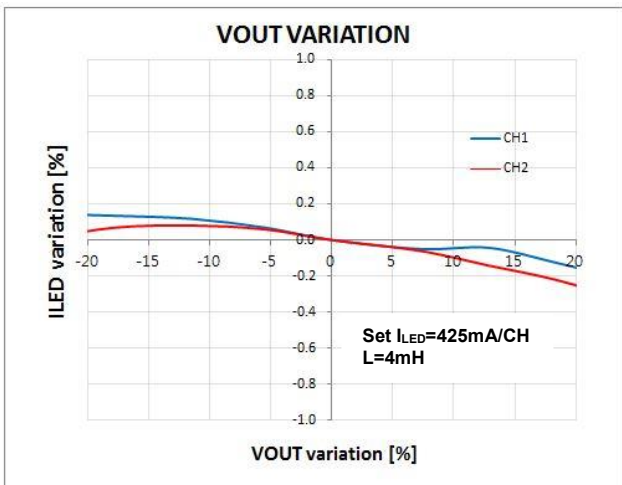
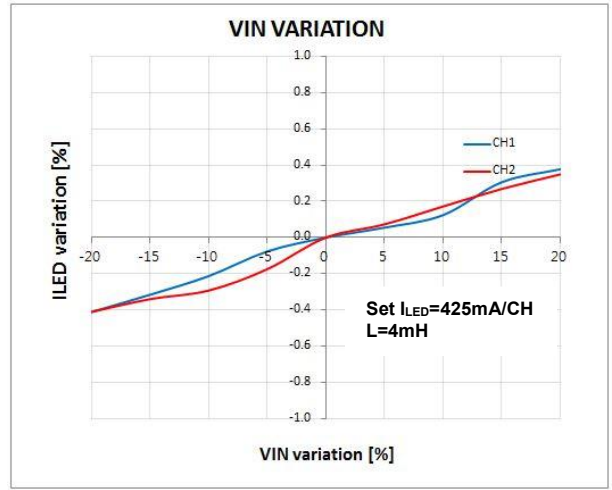
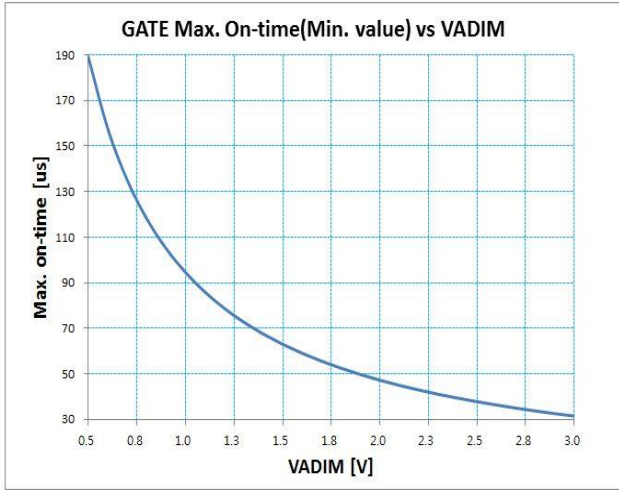

### Typical Operating Characteristics

Unless otherwise noted,  $V_{VCC} = 12V$  and  $T_A = 25^\circ C$ .

$A_V(V_{ADIM}=0.5V)$  vs. Temp

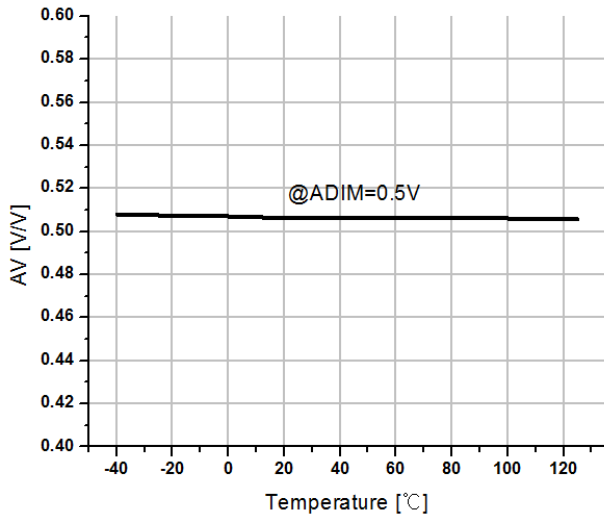

$A_V(V_{ADIM}=3.0V)$  vs. Temp

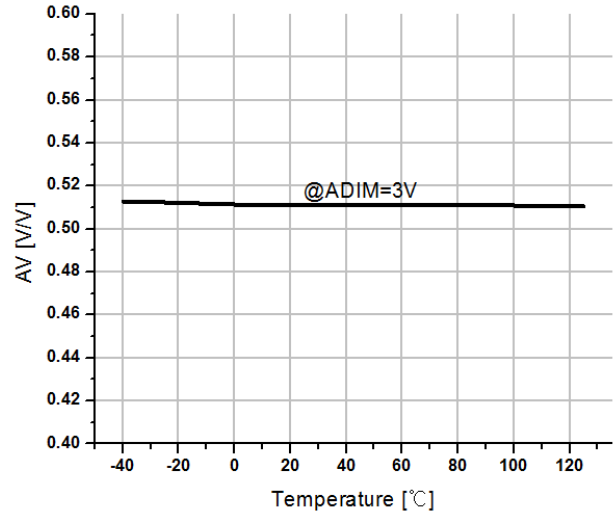

$t_{OFF1}$  vs. Temp

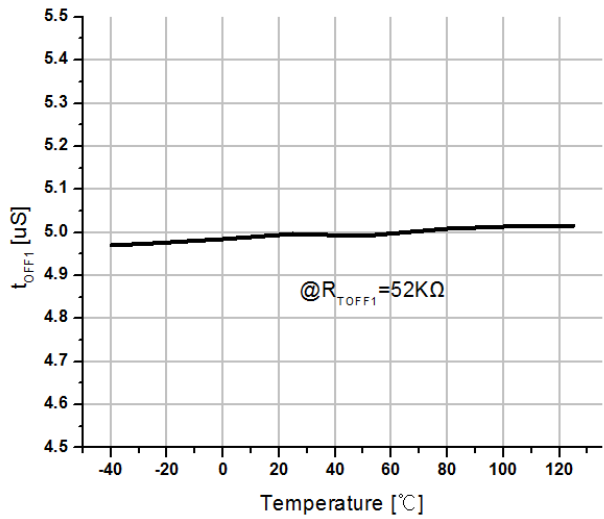

$t_{OFF2}$  vs. Temp

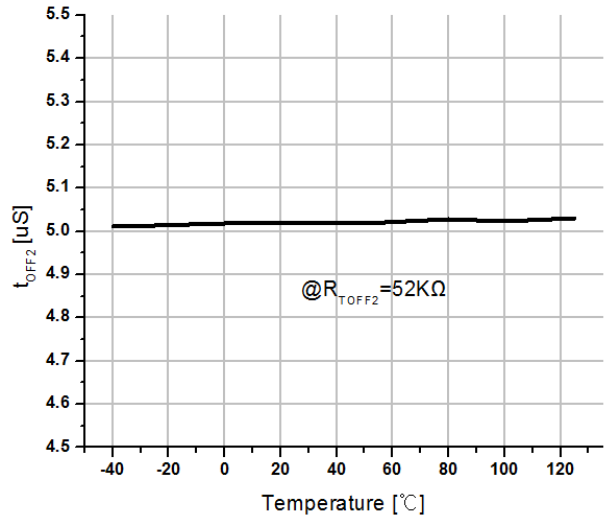

$V_{SCP}$  vs. Temp

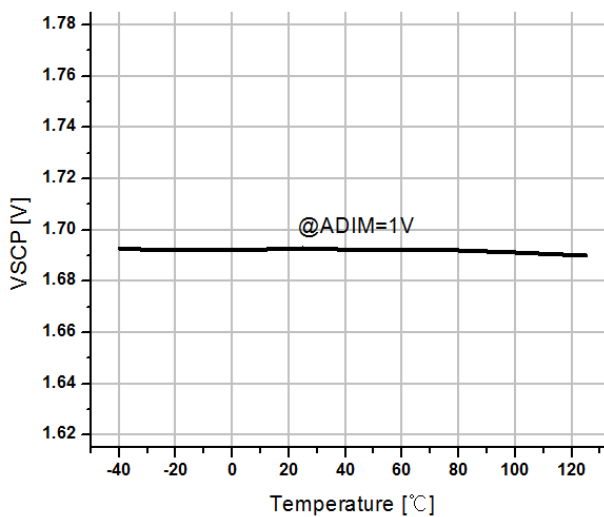

### Typical Operating Characteristics

Unless otherwise noted,  $V_{VCC} = 12V$  and  $T_A = 25^\circ C$ .

#### Constant Current Control

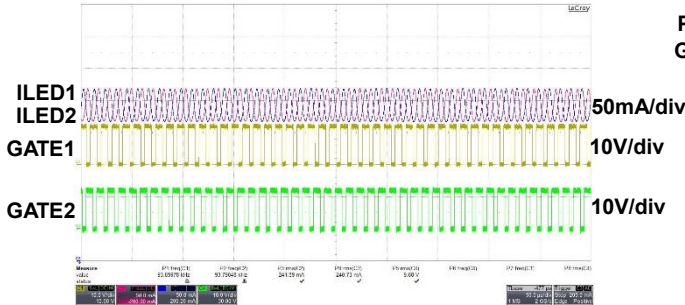

#### Min. Dimming ( $C_{OUT}=330nF$ )

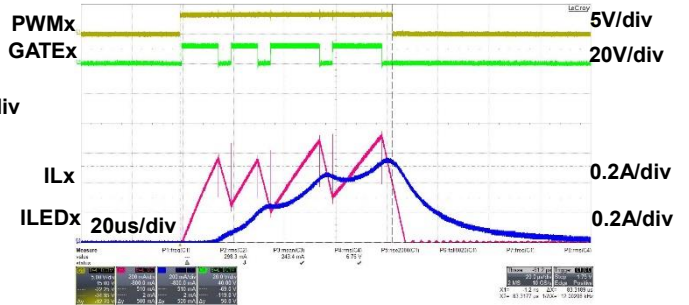

#### Soft-start (PWM Dimming, $C_{OUT}=330nF$ )

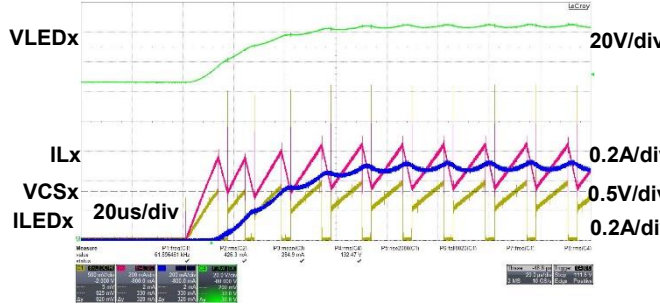

#### Soft-start (Initial, $C_{OUT}=330nF$ )

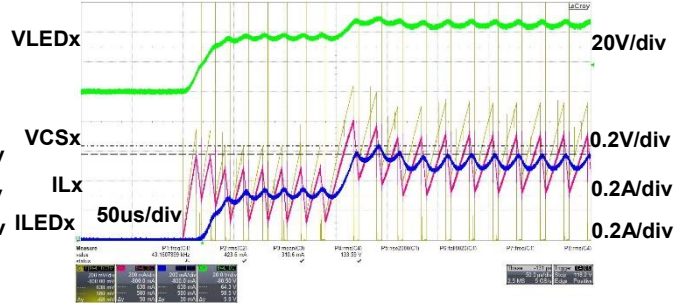

#### UVLO Release

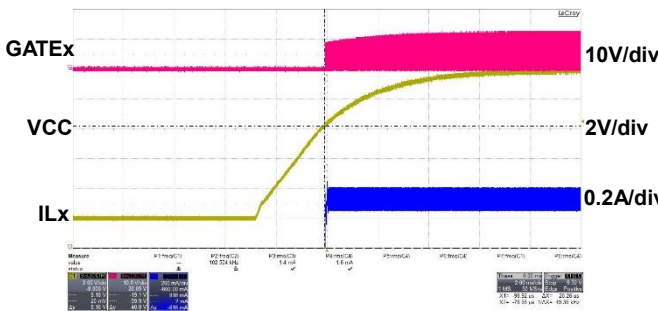

#### UVLO Lockout

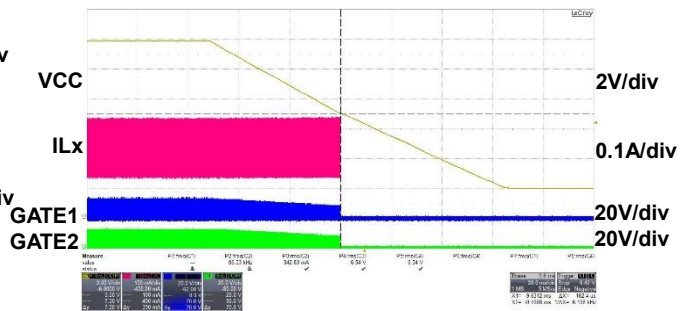

#### $V_{ADIM}$ Off

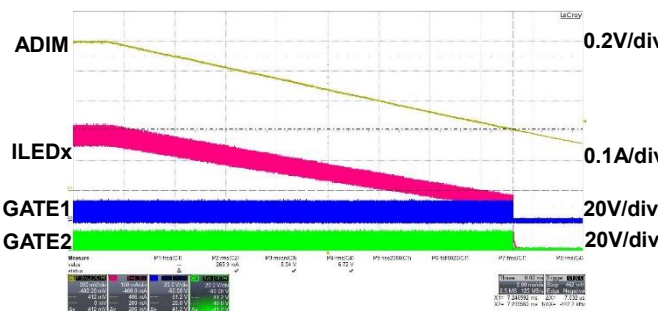

#### SCP (Inductor Short)

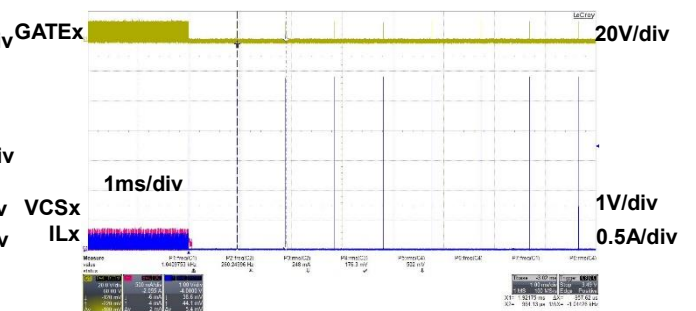



### Typical Operating Characteristics

Unless otherwise noted,  $V_{CC} = 12V$  and  $T_A = 25^\circ C$ .

SCP(Catch Diode Short)

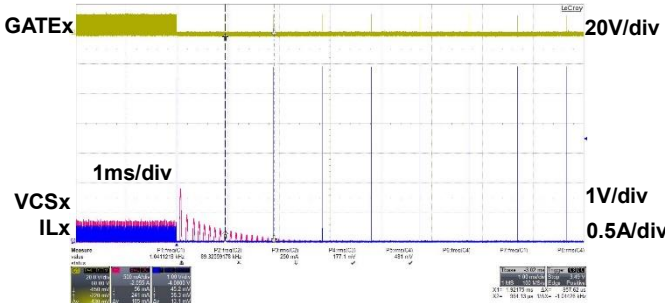

SCP(LED All Short)

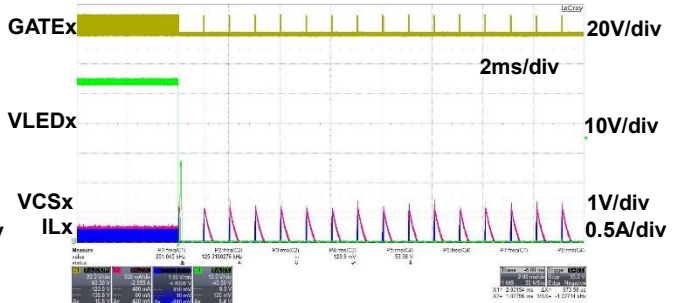

FLT Output(@ PWM On @ Running)

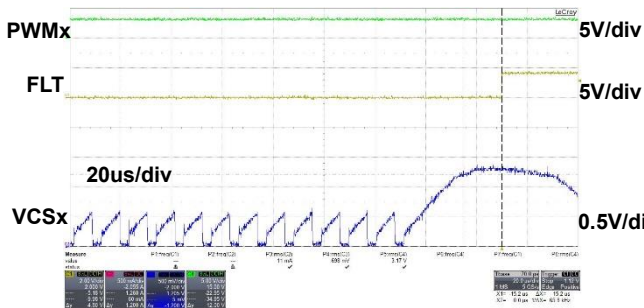

FLT Output(@ PWM Off @ Running)

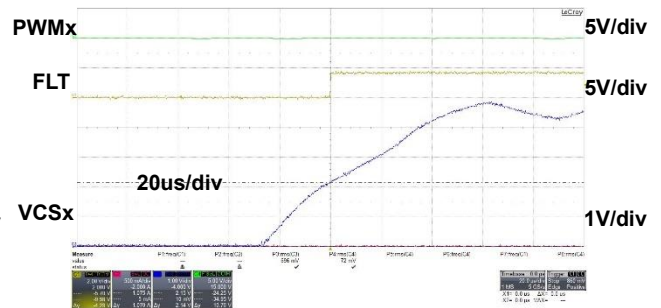

FLT Output(@ PWM On @ Start-up)

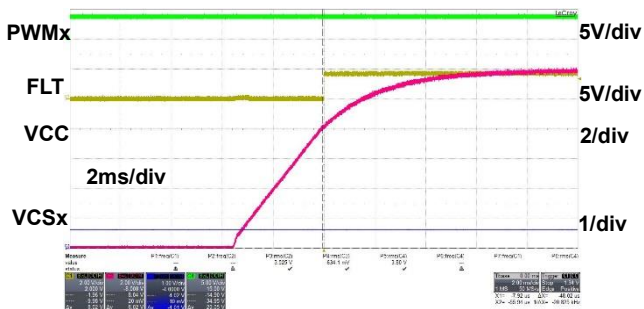

FLT Output(@ PWM Off @ Start-up)

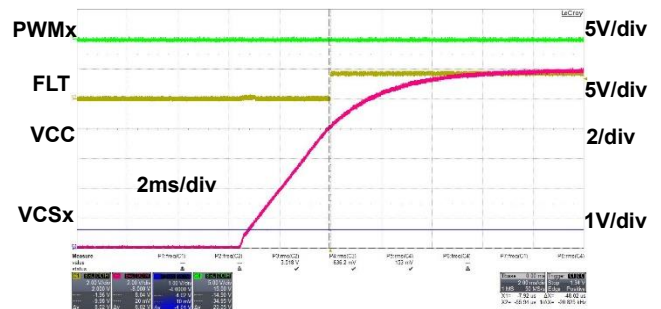

OD1 Protection

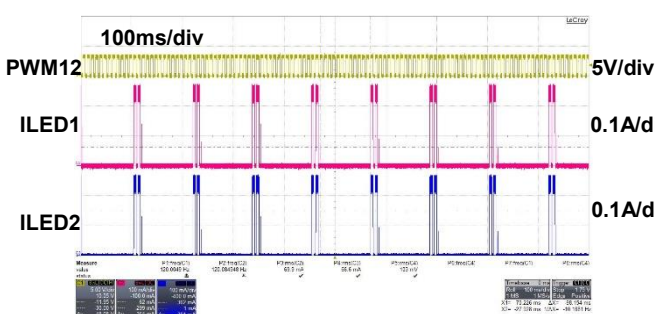

OD2 Protection

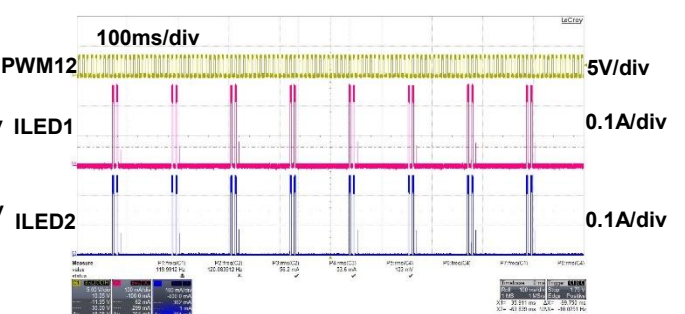

## Functional Description

### GENERAL DESCRIPTION

The MAP3612 is a 2-channel low-side single switch control, constant off-time buck controller optimized to LED backlight applications. The IC employs unique average-mode current control architecture which provides precise LED current accuracy. It does not require any external loop compensation or high side current sensing.

The IC operates at continuous conduction mode to reduce output ripple, thus small output capacitor is available. The off-time is user adjustable through the selection of an external resistor, this allows the design to be optimized for a given switching frequency range and supports wide range of input voltages.

### MAX. ON-TIME

The max. on-time of GATE is limited according to ADIM voltage as following graph.

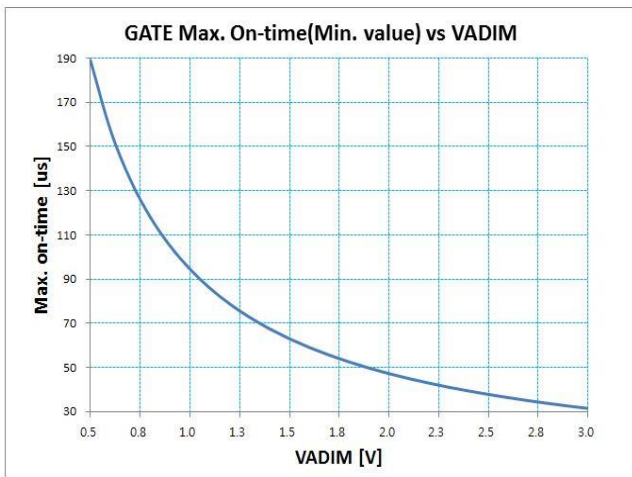

Care should be taken to choose input voltage which should not exceed this on-time limit(especially OD2 mode).

The on-time of GATE can be calculated by following equations.

$$D = \frac{V_{LED}}{V_{IN}}$$

$$t_{OFF} [us] = \frac{38.4}{400} \times R_{TOFF} [k\Omega]$$

$$t_{ON} = \frac{D \times t_{OFF}}{1 - D}$$

Finally,  $t_{ON} < t_{ON\_MAX\_Min}$  Value

### TOFF SETTING

The off-time of the GATE driver is programmed by an external resistor connected between the TOFFx pin and ground. Do not leave this pin open. The off-time is calculated by following equation.

$$R_{TOFFx} = \frac{0.4 \times t_{OFF} [us] \times 1000}{38.4} [k\Omega]$$

It can be set independently for each channels.

### LED CURRENT

The LED current is calculated by following equation.

$$I_{LED} = \frac{0.5075 \times V_{ADIM}}{R_{CS}} [A]$$

The ADIM voltage range is from 0.5V to 3V.

In terms of total system accuracy of LED current, larger inductance and slower switching frequency are recommendable to get better accuracy.

### PWM DIMMING

The brightness control of the LEDs is performed by a pulse-width modulation. The GATE output is valid only at PWM on period. This means that the GATE maintains off-state as long as PWM signal is logic low.

Care should be taken to test at low PWM duty-cycle because the output capacitor can affect rising and falling time of LED current due to its charging and discharging time.

### SOFT-START

The MAP3612 operates at peak current mode at initial start-up and every rising edge of PWM input to smooth inductor current ramp-up(output capacitor charging phase). The number of peak-controlled switch cycles is 8 times at initial start-up and 2 times at every PWM rising edge as following figure.

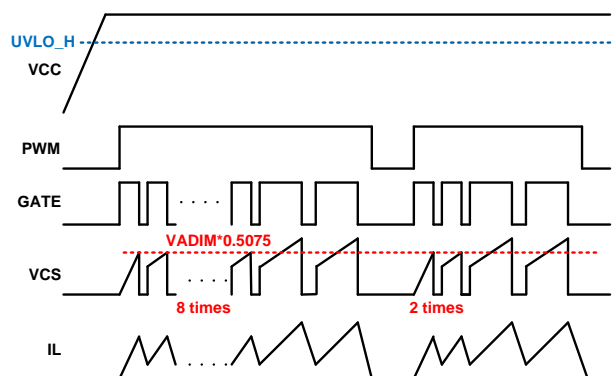

### OVER-DUTY PROTECTION

The MAP3612 provides over-duty protection for PWM inputs in case the MODE pin is logic ‘LOW’ or floated. In general, this status is 3D mode in TV applications.

The logic status on the SEL pin decides the protection duty of PWM inputs as following table.

	Available Duty	Duty Protection
OD1	Up to 55%	ODP over 56%
OD2	Up to 35%	ODP over 36%

Following table summarizes the relationship between MODE, SEL pins and ODP.

Input	HIGH	LOW or FLOATING
MODE	2D	3D
SEL	OD1	OD2

At the ODP status, the MAP3612 rechecks the protection status at every 100ms. If the error is removed, the IC status will be automatically recovered.

### SCP

If the CS voltage rises  $V_{SCP}$  during normal operation, the MAP3612 turns-off the GATE output after  $t_{DELAY}$ (typ. 300ns) time. The auto-restart time is typ. 1ms( $t_{RESTART}$ ). This protects for hard instantaneous short such as catch diode, inductor or LED bar short.

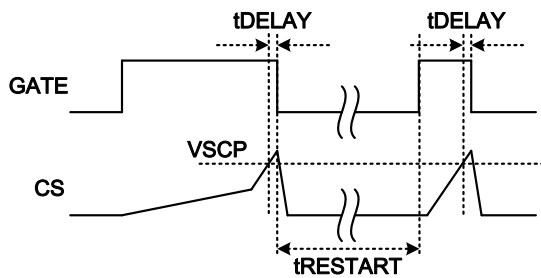

The SCP voltage varies according to ADIM voltage as following graph.

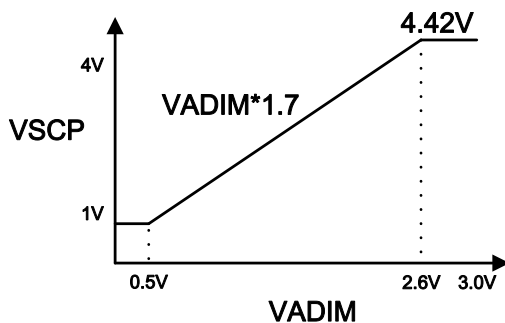

### MOSFET D-S Short Detection & FLT Output

In case the following drain-source short events of external MOSFET occur, the FLT pin goes to logic HIGH state immediately. This shuts off the whole system power supply. The protection status is latched and can be cleared by applying a complete power-on-reset(POR).

- CASE(1) : At start-up - Regardless of PWM logic state, if VCS is equal or over than  $0.5 \times VADIM$  and last over 4us.
- CASE(2) : At dimming(PWM=logic HIGH) - At first, SCP will be occurred. Even though the GATE is off-state by SCP, if the CS voltage is equal or over than  $1.7 \times VADIM$  and last over 30us.
- CASE(3) : At other condition(PWM=logic LOW) - If the CS voltage is equal or over than 1.8V and lasts over 4us.

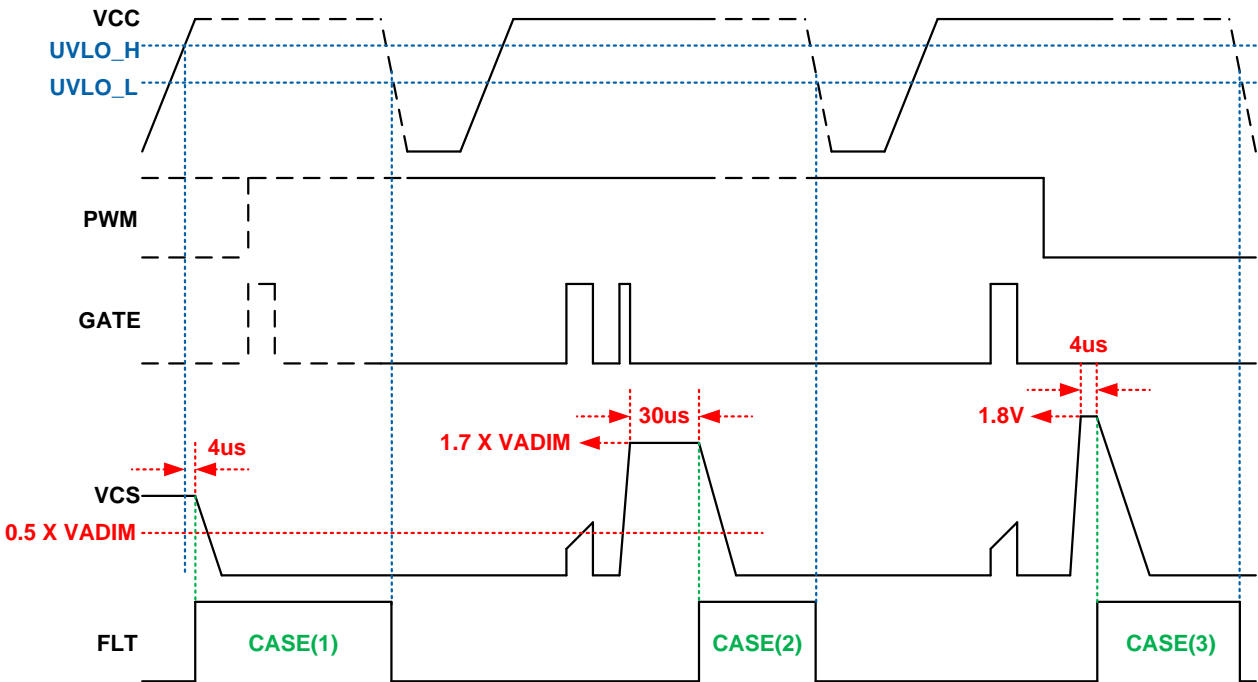

The FLT pin is at logic low state when no error is detected.

Physical Dimensions

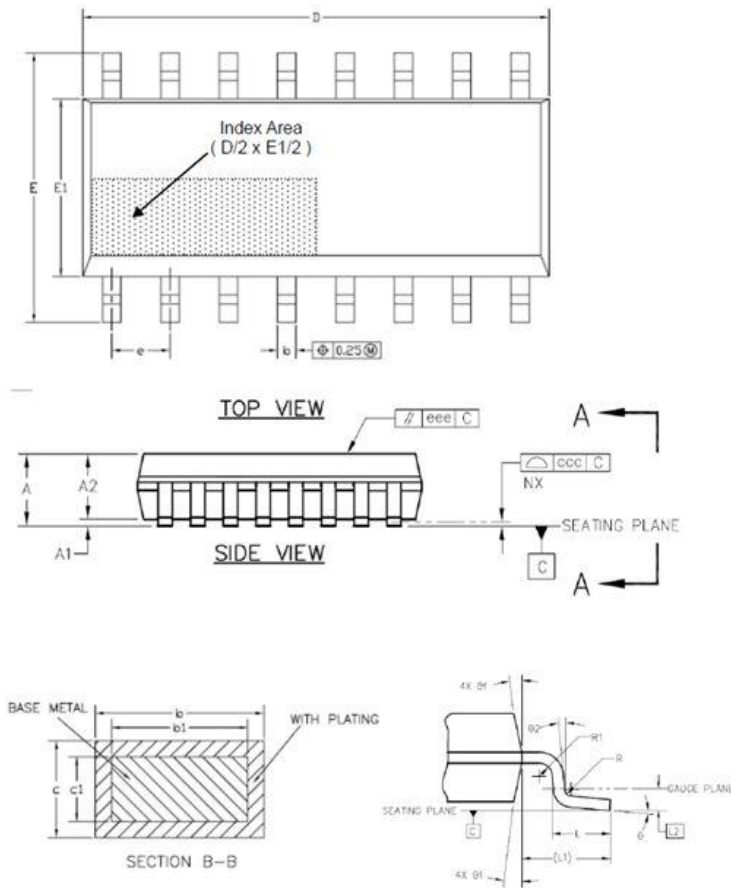

Symbol	Min	Nom	Max
A	-	-	1.80
A1	0.05	-	0.25
A2	1.25	-	-
b	0.31	-	0.51
b1	0.28	-	0.48
C	0.10	-	0.30
c1	0.10	-	0.23
D	9.70	-	10.10
E	5.70	-	6.30
E1	3.75	-	4.15
e	1.14	1.27	1.40
L	0.40	-	1.27
L1	1.04 REF		
L2	0.25 BSC		
R	0.07	-	-
R1	0.07	-	-
θ	0°	-	8°
θ1	0°	-	15°

16 Leads SOIC

Magnachip Semiconductor Ltd. doesn't not recommend the use of its products in hostile environments, including, without limitation, aircraft, nuclear power generation, medical appliances, and devices or systems in which malfunction of any product can reasonably be expected to result in a personal injury. Seller's customers using or selling Seller's products for use in such applications do so at their own risk and agree to fully defend and indemnify Seller.

Magnachip reserves the right to change the specifications and circuitry without notice at any time. Magnachip does not consider responsibility for use of any circuitry other than circuitry entirely included in a Magnachip product.

 Magnachip is a registered trademark of Magnachip Semiconductor Ltd.